

















Flanged products

4

	Figur	Seite
 ducpur® pressure pipes with 2 flanges	2019	4/4.1-11
 ducpur® pressure pipes with 1 flange	2020	4/1.12
 Wall flange		4/1.12
 90° -bend, with foot, N	2030a.90	4/2.1
 90° -bend, Q	2030.90	4/2.2
 45° -bend, FFK 45	2032.45	4/2.3
 30° -bend, FFK 30	2033.30	4/2.4
 22° -bend, FFK 22	2035.22	4/2.5
 11° -bend, FFK 11	2036.11	4/2.6
 Flanged -T, T	2040	4/3.1-2
 Flanged cross, TT	2045	4/3.3
 Flanged taper, FFR	2084	4/4.1-2
 Reduction flange, stud bolts on both sides, XR	2085	4/4.3
 Reduction flange, stud bolts on one side, XR	2085	4/4.3
 Dummy flange, flat, X	2098	4/5.1
 Dummy flange, domed, X	2099	4/5.1
Flange connection, PN10, galvanised	2007.10	4/6.1
Flange connection, PN16, galvanised	2007.16	4/6.1
Flange connection, PN10, V2A	2008.10	4/6.2
Flange connection, PN16, V2A	2008.16	4/6.2
Joint type G-ST PN 10 in water and gas quality	zu 2007/08	4/6.3
Joint type G-ST PN 16 in water and gas quality	zu 2007/08	4/6.3
Installation instructions for piping with flange connections		4/7.1-2

Pressure pipe with flanges

Pressure pipes and adapter fittings

ducpur® pressure pipe with flange(s)

Made of ductile cast iron using the centrifugal castig process with **PUR (polyurethane) internal lining, outer side zinc sprayed and coated with bitumen.**

Minimal pressure loss thanks to hydraulically smooth surface, economic.

Application: Drinking water, soft and aggressive water as well as media with pH-values between 1 and 14.

SVGW certification for water and gas pipelines.

Manufactured to ISO 2531 and EN 545 standards.

Pipe-class K12; flanges according to EN 1092-2 (screwed on and bonded).

PN > 16 on request

Version in ecopur® or with undercoat in Aluchrom on request



Pipe with threaded flanges DN 80

Fig. 2019

DN	PN bar	L mm	DE mm	e _G mm	e _{PUR1} mm	weighth kg	item no.	Suissetec
80	10	200	98	7	1.3	10.9	453192	241.118
80	10	300	98	7	1.3	12.4	456868	241.138
80	10	400	98	7	1.3	13.9	456869	241.158
80	10	500	98	7	1.3	15.4	456870	241.178
80	10	600	98	7	1.3	16.8	453193	241.218
80	10	700	98	7	1.3	18.3	453194	241.238
80	10	800	98	7	1.3	19.8	453195	241.258
80	10	1000	98	7	1.3	22.7	453197	241.278
80	10	1500	98	7	1.3	30.1	453199	241.318
80	10	2000	98	7	1.3	37.4	453201	241.338
80	10	3000	98	7	1.3	52.1	453205	241.358
80	10	4000	98	7	1.3	66.8	453208	241.378
80	16	200	98	7	1.3	10.9	453192	245.118
80	16	300	98	7	1.3	12.4	456868	245.138
80	16	400	98	7	1.3	13.9	456869	245.158
80	16	500	98	7	1.3	15.4	456870	245.178
80	16	600	98	7	1.3	16.8	453193	245.218
80	16	700	98	7	1.3	18.3	453194	245.238
80	16	800	98	7	1.3	19.8	453195	245.258
80	16	1000	98	7	1.3	22.7	453197	245.278
80	16	1500	98	7	1.3	30.1	453199	245.318
80	16	2000	98	7	1.3	37.4	453201	245.338
80	16	3000	98	7	1.3	52.1	453205	245.358
80	16	4000	98	7	1.3	66.8	453208	245.378

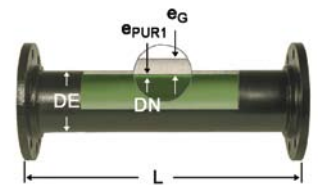

Flange with boreholes according to DIN EN 1092 part 2

Overall length (L):
 Tolerance without any special instructions ± 5 mm
 Tolerance on special order ± 1 mm
 Overall length (L): 80 – 5900 mm on request

Pipe with threaded flanges DN 100

Fig. 2019

DN	PN bar	L mm	DE mm	e _G mm	e _{PUR1} mm	weight kg	item no.	Suissetec
100	10	200	118	7.2	1.3	12.7	453209	241.119
100	10	300	118	7.2	1.3	14.5	456879	241.139
100	10	400	118	7.2	1.3	16.4	456880	241.159
100	10	500	118	7.2	1.3	18.2	456881	241.179
100	10	600	118	7.2	1.3	20.0	453210	241.219
100	10	700	118	7.2	1.3	21.9	453211	241.239
100	10	800	118	7.2	1.3	23.7	453212	241.259
100	10	1000	118	7.2	1.3	27.4	453214	241.279
100	10	1500	118	7.2	1.3	36.6	453216	241.319
100	10	2000	118	7.2	1.3	45.8	453218	241.339
100	10	3000	118	7.2	1.3	64.2	453222	241.359
100	10	4000	118	7.2	1.3	82.6	453225	241.379
100	16	200	118	7.2	1.3	12.7	453209	245.119
100	16	300	118	7.2	1.3	14.5	456879	245.139
100	16	400	118	7.2	1.3	16.4	456880	245.159
100	16	500	118	7.2	1.3	18.2	456881	245.179
100	16	600	118	7.2	1.3	20.0	453210	245.219
100	16	700	118	7.2	1.3	21.9	453211	245.239
100	16	800	118	7.2	1.3	23.7	453212	245.259
100	16	1000	118	7.2	1.3	27.4	453214	245.279
100	16	1500	118	7.2	1.3	36.6	453216	245.319
100	16	2000	118	7.2	1.3	45.8	453218	245.339
100	16	3000	118	7.2	1.3	64.2	453222	245.359
100	16	4000	118	7.2	1.3	82.6	453225	245.379

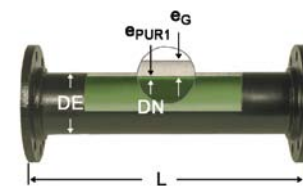

Flange with boreholes according to DIN EN 1092 part 2

Overall length (L):
 Tolerance without any special instructions ± 5 mm
 Tolerance on special order ± 1 mm

Overall length (L): 80 – 5900 mm on request

Pipe with threaded flanges DN 125

Fig. 2019

DN	PN bar	L mm	DE mm	e _G mm	e _{PUR1} mm	weight kg	item no.	Sauissetec
125	10	200	144	7.5	1.3	16.7	453226	241.121
125	10	300	144	7.5	1.3	19.1	456891	241.141
125	10	400	144	7.5	1.3	21.4	456892	241.161
125	10	500	144	7.5	1.3	23.8	456893	241.181
125	10	600	144	7.5	1.3	26.2	453227	241.221
125	10	700	144	7.5	1.3	28.5	453228	241.241
125	10	800	144	7.5	1.3	30.9	453229	241.261
125	10	1000	144	7.5	1.3	35.6	453231	241.281
125	10	1500	144	7.5	1.3	47.4	453233	241.321
125	10	2000	144	7.5	1.3	59.2	453235	241.341
125	10	3000	144	7.5	1.3	82.8	453239	241.361
125	10	4000	144	7.5	1.3	106.4	453242	241.381
125	16	200	144	7.5	1.3	16.7	453226	245.121
125	16	300	144	7.5	1.3	19.1	456891	245.141
125	16	400	144	7.5	1.3	21.4	456892	245.161
125	16	500	144	7.5	1.3	23.8	456893	245.181
125	16	600	144	7.5	1.3	26.2	453227	245.221
125	16	700	144	7.5	1.3	28.5	453228	245.241
125	16	800	144	7.5	1.3	30.9	453229	245.261
125	16	1000	144	7.5	1.3	35.6	453231	245.281
125	16	1500	144	7.5	1.3	47.4	453233	245.321
125	16	2000	144	7.5	1.3	59.2	453235	245.341
125	16	3000	144	7.5	1.3	82.8	453239	245.361
125	16	4000	144	7.5	1.3	106.4	453242	245.381

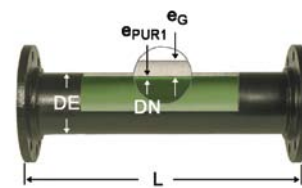

Flange with boreholes according to DIN EN 1092 part 2

Overall length (L):
Tolerance without any special instructions ± 5 mm
Tolerance on special order ± 1 mm

Overall length (L): 100 – 5900 mm on request

Subject to alteration without notice

Pipe with threaded flanges DN 150

Fig. 2019

DN	PN bar	L mm	DE mm	e _G mm	e _{PUR1} mm	weight kg	item no.	Suissetec
150	10	200	170	7.8	1.3	19.8	453243	241.122
150	10	300	170	7.8	1.3	22.7	456903	241.142
150	10	400	170	7.8	1.3	25.6	456905	241.162
150	10	500	170	7.8	1.3	28.5	456906	241.182
150	10	600	170	7.8	1.3	31.4	453244	241.222
150	10	700	170	7.8	1.3	34.3	453245	241.242
150	10	800	170	7.8	1.3	37.2	453246	241.262
150	10	1000	170	7.8	1.3	43.0	453248	241.282
150	10	1500	170	7.8	1.3	57.5	453250	241.322
150	10	2000	170	7.8	1.3	72.0	453252	241.342
150	10	3000	170	7.8	1.3	101.0	453256	241.362
150	10	4000	170	7.8	1.3	130.0	453259	241.382
150	16	200	170	7.8	1.3	19.8	453243	245.122
150	16	300	170	7.8	1.3	22.7	456903	245.142
150	16	400	170	7.8	1.3	25.6	456905	245.162
150	16	500	170	7.8	1.3	28.5	456906	245.182
150	16	600	170	7.8	1.3	31.4	453244	245.222
150	16	700	170	7.8	1.3	34.3	453245	245.242
150	16	800	170	7.8	1.3	37.2	453246	245.262
150	16	1000	170	7.8	1.3	43.0	453248	245.282
150	16	1500	170	7.8	1.3	57.5	453250	245.322
150	16	2000	170	7.8	1.3	72.0	453252	245.342
150	16	3000	170	7.8	1.3	101.0	453256	245.362
150	16	4000	170	7.8	1.3	130.0	453259	245.382

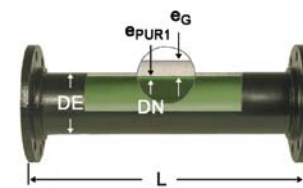

Flange with boreholes according to DIN EN 1092 part 2

Overall length (L):
Tolerance without any special instructions ± 5 mm
Tolerance on special order ± 1 mm

Overall length (L): 100 – 5900 mm on request

Pipe with threaded flanges DN 200

Fig. 2019

DN	PN bar	L mm	DE mm	e _G mm	e _{PUR1} mm	weight kg	item no.	Suissetec
200	10	200	222	8.4	1.5	29.3	453260	241.123
200	10	300	222	8.4	1.5	33.4	456915	241.143
200	10	400	222	8.4	1.5	37.5	456916	241.163
200	10	500	222	8.4	1.5	41.7	456917	241.183
200	10	600	222	8.4	1.5	45.8	453261	241.223
200	10	700	222	8.4	1.5	49.9	453262	241.243
200	10	800	222	8.4	1.5	54.0	453263	241.263
200	10	1000	222	8.4	1.5	62.3	453265	241.283
200	10	1500	222	8.4	1.5	83.0	453267	241.323
200	10	2000	222	8.4	1.5	103.6	453269	241.343
200	10	3000	222	8.4	1.5	144.9	453273	241.363
200	10	4000	222	8.4	1.5	186.2	453276	241.383
200	16	200	222	8.4	1.5	29.3	453390	245.123
200	16	300	222	8.4	1.5	33.4		245.143
200	16	400	222	8.4	1.5	37.5		245.163
200	16	500	222	8.4	1.5	41.7		245.183
200	16	600	222	8.4	1.5	45.8		245.223
200	16	700	222	8.4	1.5	49.9		245.243
200	16	800	222	8.4	1.5	54.0		245.263
200	16	1000	222	8.4	1.5	62.3		245.283
200	16	1500	222	8.4	1.5	83.0		245.323
200	16	2000	222	8.4	1.5	103.6		245.343
200	16	3000	222	8.4	1.5	144.9		245.363
200	16	4000	222	8.4	1.5	186.2		245.383

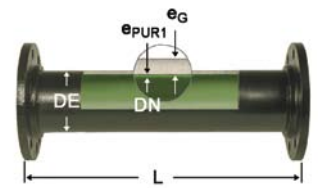

Flange with boreholes according to DIN EN 1092 part 2

Overall length (L):
Tolerance without any special instructions ± 5 mm
Tolerance on special order ± 1 mm

Overall length (L): 150 – 5900 mm on request

Subject to alteration without notice

Pipe with threaded flanges DN 250

Fig. 2019

DN	PN bar	L mm	DE mm	e _G mm	e _{PUR1} mm	weight kg	item no.	Suissetec
250	10	200	274	9	1.5	37.0	453277	241.124
250	10	300	274	9	1.5	42.4	456926	241.144
250	10	400	274	9	1.5	47.9	456928	241.164
250	10	500	274	9	1.5	53.4	456929	241.184
250	10	600	274	9	1.5	58.9	453278	241.224
250	10	700	274	9	1.5	64.4	453279	241.244
250	10	800	274	9	1.5	69.8	453280	241.264
250	10	1000	274	9	1.5	80.8	453282	241.284
250	10	1500	274	9	1.5	108.2	453284	241.324
250	10	2000	274	9	1.5	135.6	453286	241.344
250	10	3000	274	9	1.5	190.4	453290	241.364
250	10	4000	274	9	1.5	245.2	453293	241.384
250	16	200	274	9	1.5	37.0	453407	245.124
250	16	300	274	9	1.5	42.4		245.144
250	16	400	274	9	1.5	47.9		245.164
250	16	500	274	9	1.5	53.4		245.184
250	16	600	274	9	1.5	58.9		245.224
250	16	700	274	9	1.5	64.4		245.244
250	16	800	274	9	1.5	69.8		245.264
250	16	1000	274	9	1.5	80.8		245.284
250	16	1500	274	9	1.5	108.2		245.324
250	16	2000	274	9	1.5	135.6		245.344
250	16	3000	274	9	1.5	190.4		245.364
250	16	4000	274	9	1.5	245.2		245.384

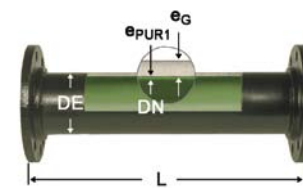

Flange with boreholes according to DIN EN 1092 part 2

Overall length (L):
Tolerance without any special instructions ± 5 mm
Tolerance on special order ± 1 mm

Overall length (L): 150 – 5900 mm on request

Pipe with threaded flanges DN 300

Fig. 2019

DN	PN bar	L mm	DE mm	e _G mm	e _{PUR1} mm	weight kg	item no.	Suissetec
300	10	200	326	9.6	1.5	47.9		241.125
300	10	300	326	9.6	1.5	54.9		241.145
300	10	400	326	9.6	1.5	61.8		241.165
300	10	500	326	9.6	1.5	68.8	456936	241.185
300	10	600	326	9.6	1.5	75.8		241.225
300	10	700	326	9.6	1.5	82.7		241.245
300	10	800	326	9.6	1.5	89.7		241.265
300	10	1000	326	9.6	1.5	103.6	453299	241.285
300	10	1500	326	9.6	1.5	138.4		241.325
300	10	2000	326	9.6	1.5	173.2	453303	241.345
300	10	3000	326	9.6	1.5	242.8	453306	241.365
300	10	4000	326	9.6	1.5	312.4	453309	241.385
300	16	200	326	9.6	1.5	47.9	453424	245.125
300	16	300	326	9.6	1.5	54.9		245.145
300	16	400	326	9.6	1.5	61.8		245.165
300	16	500	326	9.6	1.5	68.8		245.185
300	16	600	326	9.6	1.5	75.8		245.225
300	16	700	326	9.6	1.5	82.7		245.245
300	16	800	326	9.6	1.5	89.7		245.265
300	16	1000	326	9.6	1.5	103.6		245.285
300	16	1500	326	9.6	1.5	138.4		245.325
300	16	2000	326	9.6	1.5	173.2		245.345
300	16	3000	326	9.6	1.5	242.8		245.365
300	16	4000	326	9.6	1.5	312.4		245.385

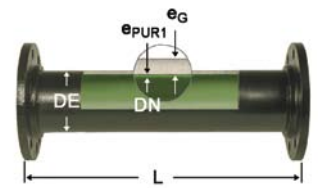

Flange with boreholes according to DIN EN 1092 part 2

Overall length (L):
Tolerance without any special instructions ± 5 mm
Tolerance on special order ± 1 mm

Overall length (L): 150 – 5900 mm on request

Subject to alteration without notice

Pipe with threaded flanges DN 350

Fig. 2019

DN	PN bar	L mm	DE mm	e _G mm	e _{PUR1} mm	weight kg	Suissetec
350	10	200	378	10.2	1.5	61.2	241.126
350	10	300	378	10.2	1.5	69.7	241.146
350	10	400	378	10.2	1.5	78.3	241.166
350	10	500	378	10.2	1.5	86.9	241.186
350	10	600	378	10.2	1.5	95.5	241.226
350	10	700	378	10.2	1.5	104.1	241.246
350	10	800	378	10.2	1.5	112.6	241.266
350	10	1000	378	10.2	1.5	129.8	241.286
350	10	1500	378	10.2	1.5	172.7	241.326
350	10	2000	378	10.2	1.5	215.6	241.346
350	10	3000	378	10.2	1.5	301.4	241.366
350	10	4000	378	10.2	1.5	387.2	241.386
350	16	200	378	10.2	1.5	61.2	245.126
350	16	300	378	10.2	1.5	69.7	245.146
350	16	400	378	10.2	1.5	78.3	245.166
350	16	500	378	10.2	1.5	86.9	245.186
350	16	600	378	10.2	1.5	95.5	245.226
350	16	700	378	10.2	1.5	104.1	245.246
350	16	800	378	10.2	1.5	112.6	245.266
350	16	1000	378	10.2	1.5	129.8	245.286
350	16	1500	378	10.2	1.5	172.7	245.326
350	16	2000	378	10.2	1.5	215.6	245.346
350	16	3000	378	10.2	1.5	301.4	245.366
350	16	4000	378	10.2	1.5	387.2	245.386

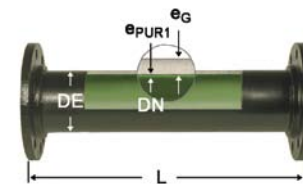

Flange with boreholes according to DIN EN 1092 part 2

Overall length (L):
 Tolerance without any special instructions ± 5 mm
 Tolerance on special order ± 1 mm

Overall length (L): 200 – 5900 mm on request

Pipe with threaded flanges DN 400

Fig. 2019

DN	PN bar	L mm	DE mm	e _G mm	e _{PUR1} mm	weight kg	Suissetec
400	10	200	429	10.8	1.5	70.6	241.127
400	10	300	429	10.8	1.5	80.9	241.147
400	10	400	429	10.8	1.5	91.2	241.167
400	10	500	429	10.8	1.5	101.6	241.187
400	10	600	429	10.8	1.5	111.9	241.227
400	10	700	429	10.8	1.5	122.2	241.247
400	10	800	429	10.8	1.5	132.5	241.267
400	10	1000	429	10.8	1.5	153.1	241.287
400	10	1500	429	10.8	1.5	204.7	241.327
400	10	2000	429	10.8	1.5	256.2	241.347
400	10	3000	429	10.8	1.5	359.3	241.367
400	10	4000	429	10.8	1.5	462.4	241.387
400	16	200	429	10.8	1.5	70.6	245.127
400	16	300	429	10.8	1.5	80.9	245.147
400	16	400	429	10.8	1.5	91.2	245.167
400	16	500	429	10.8	1.5	101.6	245.187
400	16	600	429	10.8	1.5	111.9	245.227
400	16	700	429	10.8	1.5	122.2	245.247
400	16	800	429	10.8	1.5	132.5	245.267
400	16	1000	429	10.8	1.5	153.1	245.287
400	16	1500	429	10.8	1.5	204.7	245.327
400	16	2000	429	10.8	1.5	256.2	245.347
400	16	3000	429	10.8	1.5	359.3	245.367
400	16	4000	429	10.8	1.5	462.4	245.387

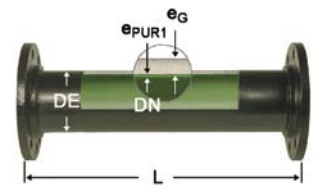

Flange with boreholes according to DIN EN 1092 part 2

Overall length (L):
Tolerance without any special instructions ± 5 mm
Tolerance on special order ± 1 mm

Overall length (L): 150 – 5900 mm on request

Pipe with threaded flanges DN 500

Fig. 2019

DN	PN bar	L mm	DE mm	e _G mm	e _{PUR1} mm	weight kg	Suissetec
500	10	200	532	12	1.5	106.4	-
500	10	300	532	12	1.5	120.6	-
500	10	400	532	12	1.5	134.8	-
500	10	500	532	12	1.5	149.1	-
500	10	600	532	12	1.5	163.3	-
500	10	700	532	12	1.5	177.5	-
500	10	800	532	12	1.5	191.7	-
500	10	1000	532	12	1.5	220.1	-
500	10	1500	532	12	1.5	291.2	-
500	10	2000	532	12	1.5	362.2	-
500	10	3000	532	12	1.5	504.3	-
500	10	4000	532	12	1.5	646.4	-
500	16	200	532	12	1.5	106.4	-
500	16	300	532	12	1.5	120.6	-
500	16	400	532	12	1.5	134.8	-
500	16	500	532	12	1.5	149.1	-
500	16	600	532	12	1.5	163.3	-
500	16	700	532	12	1.5	177.5	-
500	16	800	532	12	1.5	191.7	-
500	16	1000	532	12	1.5	220.1	-
500	16	1500	532	12	1.5	291.2	-
500	16	2000	532	12	1.5	362.2	-
500	16	3000	532	12	1.5	504.3	-
500	16	4000	532	12	1.5	646.4	-

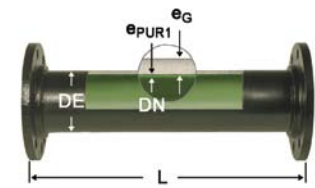

Flange with boreholes according to DIN EN 1092 part 2

Overall length (L):
 Tolerance without any special instructions ± 5 mm
 Tolerance on special order ± 1 mm
 Overall length (L): 200 – 5900 mm on request

Pipe with threaded flanges DN 600

Fig. 2019

DN	PN bar	L mm	DE mm	e _G mm	e _{PUR1} mm	weight kg	Suissetec
600	10	200	635	13.2	1.5	137.3	-
600	10	300	635	13.2	1.5	156.0	-
600	10	400	635	13.2	1.5	174.6	-
600	10	500	635	13.2	1.5	193.3	-
600	10	600	635	13.2	1.5	211.9	-
600	10	700	635	13.2	1.5	230.6	-
600	10	800	635	13.2	1.5	249.2	-
600	10	1000	635	13.2	1.5	286.5	-
600	10	1500	635	13.2	1.5	379.8	-
600	10	2000	635	13.2	1.5	473.0	-
600	10	3000	635	13.2	1.5	659.5	-
600	10	4000	635	13.2	1.5	846.0	-
600	16	200	635	13.2	1.5	137.3	-
600	16	300	635	13.2	1.5	156.0	-
600	16	400	635	13.2	1.5	174.6	-
600	16	500	635	13.2	1.5	193.3	-
600	16	600	635	13.2	1.5	211.9	-
600	16	700	635	13.2	1.5	230.6	-
600	16	800	635	13.2	1.5	249.2	-
600	16	1000	635	13.2	1.5	286.5	-
600	16	1500	635	13.2	1.5	379.8	-
600	16	2000	635	13.2	1.5	473.0	-
600	16	3000	635	13.2	1.5	659.5	-
600	16	4000	635	13.2	1.5	846.0	-

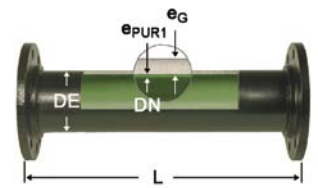

Flange with boreholes according to DIN EN 1092 part 2

Overall length (L):
Tolerance without any special instructions ± 5 mm
Tolerance on special order ± 1 mm

Overall length (L): 200 – 5900 mm on request

Subject to alteration without notice

Pressure pipe with flanges

Pressure pipes and adapter fittings

Pipe with one threaded flange

Fig. 2020

DN	PN bar	L mm	DE mm	e _G mm	e _{PUR1} mm	weight kg	item no.	Suissetec
80	10	1000	98	7	1.3	18.7	453925	241.578
80	16	1000	98	7	1.3	18.7	453925	245.578
100	10	1000	118	7.2	1.3	22.9	453942	241.579
100	16	1000	118	7.2	1.3	22.9	453942	245.579
125	10	1000	144	7.5	1.3	29.6	453959	241.581
125	16	1000	144	7.5	1.3	29.6	453959	245.581
150	10	1000	170	7.8	1.3	36.0	453976	241.582
150	16	1000	170	7.8	1.3	36.0	453976	245.582
200	10	1000	222	8.4	1.5	51.8	453993	241.583
200	16	1000	222	8.4	1.5	51.8		245.583
250	10	1000	274	9	1.5	67.8	454010	241.584
250	16	1000	274	9	1.5	67.8		245.584
300	10	1000	326	9.6	1.5	86.6	454027	241.585
300	16	1000	326	9.6	1.5	86.6		245.585
350	10	1000	378	10.2	1.5	85.8		241.586
350	16	1000	378	10.2	1.5	85.8		245.586
400	10	1000	429	10.8	1.5	128.1		241.587
400	16	1000	429	10.8	1.5	128.1		245.587
500	10	1000	532	12	1.5	181.1		-
500	16	1000	532	12	1.5	181.1		-
600	10	1000	635	13.2	1.5	236.5		-
600	16	1000	635	13.2	1.5	236.5		-

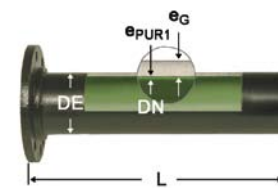

Flange with boreholes according to DIN EN 1092 part 2

Overall length (L):
 Tolerance without any special instructions ± 5 mm
 Tolerance on special order ± 1 mm
 Overall length (L): 80 – 5900 mm on request

Wall flange

DN	weight kg	item no.	Suissetec
80	4.0		-
100	4.5		-
125	6.0		-
150	7.0		-
200	10.5		-
250	13.0		-
300	17.0		-



Large DN on request

Subject to alteration without notice

ecofit® bends with flange connectors

Adapter fittings made of ductile cast iron (EN-GJS) to EN 545 standard.

Thick epoxy-resin coating (min. 250 µm) to DIN 3476 standard.

PN > 16 on request.



90°-bend with foot, 2 flanges (N)

Fig. 2030a.90

DN	PN bar	t mm	h mm	c mm	weight kg	item no.	Suissetec
80	10	165	110	180	13.0	150022	242.418
80	16	165	110	180	13.2	150022	246.418
100	10	180	125	200	16.9	150023	242.419
100	16	180	125	200	16.9	150023	246.419
125	10	200	140	225	22.1	150024	242.421
125	16	200	140	225	22.1	150024	246.421
150	10	220	160	250	28.8	150025	242.422
150	16	220	160	250	28.8	150025	246.422
200	10	260	190	300	46.2	150026	242.423
200	16	260	190	300	45.2	150027	246.423
250	10	350	225	350	73.5	150028	242.424
250	16	350	225	350	72.5	150029	246.424
300	10	400	255	400	103.9	150030	242.425
300	16	400	255	400	102.9	150031	246.425
350	10	450	290	450	137.0	455579	242.426
350	16	450	290	450	142.0	456760	246.426
400	10	500	320	500	176.4	150032	242.427
400	16	500	320	500	186.4	150033	246.427
500	10	600	385	600	281.0	150034	-
500	16	600	385	600	311.0	150035	-
600	10	700	450	700	425.0	150036	-
600	16	700	450	700	478.0	150037	-



Flange with boreholes according to DIN EN 1092 part 2

90°-bend, 2 flanges (Q)

Fig. 2030.90

DN	PN bar	t mm	weight kg	item no.	Suissetec
80	10	165	9.5	150000	242.218
80	16	165	9.7	150000	246.218
100	10	180	12.0	150001	242.219
100	16	180	12.0	150001	246.219
125	10	200	15.6	150002	242.221
125	16	200	15.6	150002	246.221
150	10	220	19.8	150003	242.222
150	16	220	19.8	150003	246.222
200	10	260	31.2	150004	242.223
200	16	260	30.2	150005	246.223
250	10	350	50.0	150006	242.224
250	16	350	49.0	150007	246.224
300	10	400	69.9	150008	242.225
300	16	400	68.9	150009	246.225
350	10	450	90.5	112133	242.226
350	16	450	96.0	112142	246.226
400	10	500	114.5	150010	242.227
400	16	500	125.5	150011	246.227
500	10	600	179.0	150012	-
500	16	600	209.0	150013	-
600	10	700	269.0	150014	-
600	16	700	322.0	150015	-
700	10	800	381.5	150016	-
700	16	800	411.5	150017	-



Flange with boreholes according to DIN EN 1092 part 2

45°-bend, 2 flanges (FFK 45)

Fig. 2032.45

DN		t mm	weight kg	item no.	Suissetec
80	10	130	9.2	150044	242.258
80	16	130	9.2	150044	246.258
100	10	140	11.3	150045	242.259
100	16	140	11.3	150045	246.259
125	10	150	14.5	150046	242.261
125	16	150	14.5	150046	246.261
150	10	160	18.4	150047	242.262
150	16	160	18.4	150047	246.262
200	10	180	27.5	150048	242.263
200	16	180	27.0	150049	246.263
250	10	350	54.5	150050	242.264
250	16	350	54.0	150051	246.264
300	10	400	77.2	150052	242.265
300	16	400	76.2	150053	246.265
350	10	298	77.0	112173	242.266
350	16	298	82.5	112182	246.266
400	10	324	94.4	150054	242.267
400	16	324	106.4	150055	246.267
500	10	375	143.5	150056	-
500	16	375	173.5	150057	-
600	10	426	210.0	150058	-
600	16	426	263.0	150059	-
700	10	478	292.5	150060	-
700	16	478	322.5	150061	-

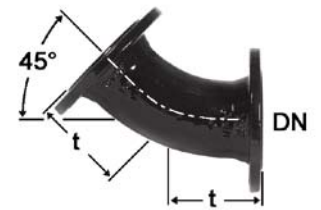

Flange with boreholes according to DIN EN 1092 part 2

30°-bend, 2 flanges (FFK 30)

Fig. 2033.33

DN	PN bar	t mm	weight kg	item no.	Suissetec
80	10	130	9.5	150067	242.278
80	16	130	9.5	150067	246.278
100	10	140	11.9	150068	242.279
100	16	140	11.9	150068	246.279
125	10	150	15.3	150069	242.281
125	16	150	15.3	150069	246.281
150	10	160	19.5	150070	242.282
150	16	160	19.5	150070	246.282
200	10	180	29.0	150071	242.283
200	16	180	27.5	150072	246.283
250	10	210	41.5	150073	242.284
250	16	210	40.5	150074	246.284
300	10	255	59.5	150075	242.285
300	16	255	59.0	150076	246.285
350	10	165	57.0	112273	242.286
350	16	165	62.5	112282	246.286
400	10	183	73.0	150077	242.287
400	16	183	82.5	150078	246.287
500	10	220	109.0	150079	-
500	16	220	137.0	150080	-
600	10	309	212.0	150081	-
600	16	309	257.0	150082	-
700	10	346	360.0	150083	-
700	16	346	386.0	150084	-

To works specifications



Flange with boreholes according to DIN EN 1092 part 2

22°-bend, 2 flanges (FFK 30)

Fig. 2035.22

DN	PN bar	t mm	weight kg	item no.	Suissetec
80	10	130	9.5	150089	242.318
80	16	130	9.5	150089	246.318
100	10	140	11.9	150090	242.319
100	16	140	11.9	150090	246.319
125	10	150	15.3	150091	242.321
125	16	150	15.3	150091	246.321
150	10	160	19.7	150092	242.322
150	16	160	19.7	150092	246.322
200	10	180	29.0	150093	242.323
200	16	180	27.5	150094	246.323
250	10	210	41.5	150095	242.324
250	16	210	41.0	150096	246.324
300	10	255	60.0	150097	242.325
300	16	255	59.0	150098	246.325
350	10	140	53.0	112543	242.326
350	16	140	58.5	112644	246.326
400	10	153	67.0	150099	242.327
400	16	153	75.5	150100	246.327
500	10	185	99.0	150101	-
500	16	185	127.0	150102	-
600	10	254	182.0	150103	-
600	16	254	227.0	150104	-
700	10	284	313.0	150105	-
700	16	284	339.0	150106	-

To works specifications

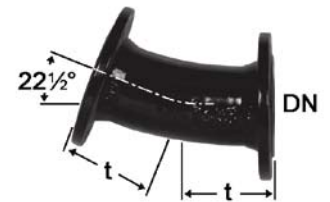

Flange with boreholes according to DIN EN 1092 part 2

11°-bend, 2 flanges (FFK 11)

Fig. 2036.11

DN	PN bar	t mm	weight kg	item no.	Suissetec
80	10	130	9.5	150110	242.338
80	16	130	9.5	150110	246.378
100	10	140	11.9	150111	242.339
100	16	140	11.9	150111	246.379
125	10	150	15.3	150112	242.341
125	16	150	15.3	150112	246.381
150	10	160	19.0	150113	242.342
150	16	160	19.0	150113	246.382
200	10	180	26.0	150114	242.343
200	16	180	25.0	150115	246.383
250	10	210	41.5	150116	242.344
250	16	210	41.0	150117	246.384
300	10	255	60.0	150118	242.345
300	16	255	59.5	150119	246.385
350	10	105	47.5	112558	242.346
350	16	105	53.0	112653	246.386
400	10	113	58.0	150120	242.347
400	16	113	67.5	150121	246.387
500	10	135	85.0	150122	-
500	16	135	113.0	150123	-
600	10	174	157.0	150124	-
600	16	174	202.0	150125	-
700	10	194	243.0	150126	-
700	16	194	269.0	150127	-

To works specifications



Flange with boreholes according to DIN EN 1092 part 2

ecofit® flanged adapter fittings (with 1 or 2 branches)

Adapter fittings made of ductile cast iron (EN-GJS) to EN 545 standard.

Thick epoxy-resin coating (min. 250 µm) to DIN 3476 standard.

PN > 16 on request.



Fig. 2040

Flange-Tee (T)

DN ₁	DN ₂	PN bar	L mm	h mm	weight kg	item no.	Suissetec
80	80	10	330	165	15.3	150132	243.118
80	80	16	330	165	15.6	150132	247.118
100*	50	10	360	170	17.1	150133	243.159
100*	50	16	360	170	17.1	150133	247.159
100*	65	10	360	170	19.0	150134	243.179
100*	65	16	360	170	19.0	150134	247.179
100	80	10	360	175	18.3	150135	243.219
100	80	16	360	175	18.4	150135	247.219
100	100	10	360	180	19.0	150136	243.119
100	100	16	360	180	19.0	150136	247.119
125	80	10	400	190	22.8	150137	243.221
125	80	16	400	190	22.8	150137	247.221
125	100	10	400	195	23.8	150138	243.241
125	100	16	400	195	23.8	150138	247.241
125	125	10	400	200	25.2	150139	243.121
125	125	16	400	200	25.2	150139	247.121
150*	50	10	440	200	30.5	150140	243.162
150*	50	16	440	200	30.5	150140	247.162
150	80	10	440	205	28.5	150141	243.222
150	80	16	440	205	28.5	150141	247.222
150	100	10	440	210	29.4	150142	243.242
150	100	16	440	210	29.4	150142	247.242
150	125	10	440	215	30.9	150143	243.262
150	125	16	440	215	30.9	150143	247.262
150	150	10	440	220	32.3	150144	243.122
150	150	16	440	220	32.3	150144	247.122
200	100	10	520	240	43.1	150145	243.243
200	100	16	520	240	42.6	150146	247.243
200*	125	10	520	245	51.0	150147	243.263
200*	125	16	520	245	51.0	150148	247.263
200	150	10	520	250	46.0	150149	243.283
200	150	16	520	250	45.5	150150	247.283
200	200	10	520	260	49.5	150151	243.123
200	200	16	520	260	48.5	150152	247.123
250	100	10	700	275	67.6	150153	243.244
250	100	16	700	275	66.6	150154	247.244
250	150	10	700	300	81.0	150155	243.284
250	150	16	700	300	80.0	150156	247.284

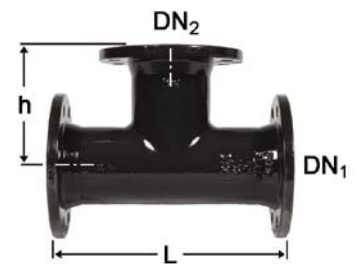

Flange with boreholes according to DIN EN 1092 part 2

Subject to alteration without notice

Flange-Tee (T)

Fig. 2040

DN ₁	DN ₂	PN bar	L mm	h mm	weight kg	item no.	Suissetec
250	200	10	700	325	75.2	150157	243.324
250	200	16	700	325	74.2	150158	247.324
250	250	10	700	350	81.0	150159	243.124
250	250	16	700	350	80.0	150160	247.124
300	100	10	800	300	93.8	150161	243.245
300	100	16	800	300	92.8	150162	247.245
300*	150	10	800	325	101.0	150163	243.285
300	150	16	800	325	100.0	150164	247.285
300	200	10	800	350	102.4	150165	243.325
300	200	16	800	350	101.4	150166	247.325
300*	250	10	800	400	113.9	150167	243.345
300	250	16	800	400	112.9	150168	247.345
300	300	10	800	375	114.0	150169	243.125
300	300	16	800	375	113.0	150170	247.125
350	100	10	850	325	117.0	112078	243.246
350	100	16	850	325	122.0	112097	247.246
350	200	10	850	325	122.0	112079	243.326
350	200	16	850	325	128.0	112098	247.326
350	350	10	850	425	144.0	112077	243.126
350	350	16	850	425	152.0	112096	247.126
400	200	10	900	350	147.3	150171	243.327
400	200	16	900	350	158.3	150172	247.327
400	400	10	900	450	168.5	150173	243.127
400	400	16	900	450	185.5	150174	247.127
500	200	10	1000	400	214.5	150175	-
500	200	16	1000	400	244.5	150176	-
500	500	10	1000	500	243.6	150177	-
500	500	16	1000	500	289.6	150178	-
600	200	10	1100	450	304.0	150179	-
600	200	16	1100	450	356.0	150180	-
600	400	10	1100	550	323.0	150181	-
600	400	16	1100	550	382.0	150182	-
600	600	10	1100	550	343.0	150183	-
600	600	16	1100	550	422.0	150184	-
700	200	10	650	525	265.9	150185	-
700	200	16	650	525	295.9	150186	-
700	400	10	870	555	337.5	150187	-
700	400	16	870	555	372.5	150188	-
700	700	10	1200	585	459.0	150189	-
700	700	16	1200	585	504.0	150190	-

* to factory standards

Subject to alteration without notice

Flange-cross (TT)

Fig. 2045

DN ₁	DN ₂	PN bar	L mm	h mm	weight kg	item no.	Suissetec
80	80	10	330	165	20.0	150194	243.418
80	80	16	330	165	20.0	150194	247.418
100	100	10	360	180	26.0	150195	243.419
100	100	16	360	180	26.0	150195	247.419
125	125	10	400	200	39.0	150196	243.421
125	125	16	400	200	39.0	150196	247.421
150	150	10	440	220	39.0	150197	243.422
150	150	16	440	220	39.0	150197	247.422
200	200	10	520	260	58.0	150198	243.423
200	200	16	520	260	58.0	150199	247.423
250	250	10	700	350	120.0	150200	243.424
250	250	16	700	350	120.0	150201	247.424
300	300	10	800	400	155.0	150202	243.425
300	300	16	800	400	160.0	150203	247.425
400	400	10	900	450	218.0	150204	243.427
400	400	16	900	450	225.0	150205	247.427

To works specifications

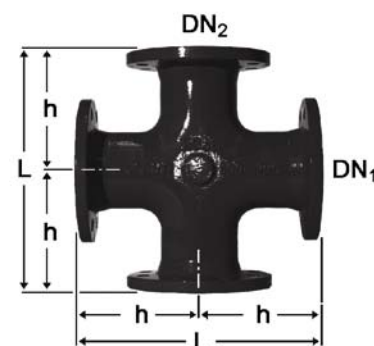

Flange with boreholes according to DIN EN 1092 part 2

ecofit® taper with flange connectors

Adapter fittings made of ductile cast iron (EN-GJS) to EN 545 standard.
 Thick epoxy-resin coating (min. 250 µm) to DIN 3476 standard.
 PN > 16 bar on request.



Taper with flanges (FFR)

Fig. 2084

DN ₁	DN ₂	PN bar	L mm	weight kg	item no.	Suissetec
80*	40	10	200	6.6	150213	244.138
80*	40	16	200	6.7	150213	248.138
80*	50	10	200	7.2	150214	244.158
80*	50	16	200	7.3	150214	248.158
80	65	10	200	7.9	150215	244.178
80	65	16	200	8.0	150215	248.178
100*	40	10	200	11.5	150216	244.139
100*	40	16	200	11.5	150216	248.139
100	50	10	200	8.1	150217	244.159
100	50	16	200	8.1	150217	248.159
100*	65	10	200	8.7	150218	244.179
100*	65	16	200	8.7	150218	248.179
100	80	10	200	9.3	150219	244.219
100	80	16	200	9.4	150219	248.219
125*	65	10	305	13.2	150220	244.181
125*	65	16	305	13.2	150220	248.181
125*	80	10	200	10.5	150221	244.221
125*	80	16	200	10.6	150221	248.221
125	100	10	200	11.3	150222	244.241
125	100	16	200	11.3	150222	248.241
150	80	10	200	12.0	150223	244.222
150	80	16	200	12.0	150223	248.222
150	100	10	200	12.8	150224	244.242
150	100	16	200	12.8	150224	248.242
150	125	10	200	14.0	150225	244.262
150	125	16	200	14.0	150225	248.262
200	80	10	300	17.9	150226	244.223
200	80	16	300	17.7	150227	248.223
200	100	10	300	18.9	150228	244.243
200	100	16	300	18.6	150229	248.243
200	125	10	300	20.5	150230	244.263
200	125	16	300	20.0	150231	248.263
200	150	10	300	21.9	150232	244.283
200	150	16	300	21.9	150233	248.283
250*	100	10	300	26.0	150236	244.244
250*	100	16	300	26.0	150237	248.244
250*	125	10	300	41.0	150238	244.264
250*	125	16	300	40.5	150239	248.264
250*	150	10	300	44.0	150240	244.284

Subject to alteration without notice



Flange with boreholes according to DIN EN 1092 part 2

Taper with flanges (FFR)

Fig. 2084

DN ₁	DN ₂	PN bar	L mm	weight kg	item no.	Suissetec
250*	150	16	300	43.5	150241	248.284
250*	200	10	300	30.6	150242	244.324
250*	200	16	300	30.1	150243	248.324
300*	150	10	300	33.0	150244	244.285
300*	150	16	300	32.5	150245	248.285
300*	200	10	300	35.9	150246	244.325
300*	200	16	300	35.4	150247	248.325
300	250	10	300	40.8	150248	244.345
300	250	16	300	39.8	150249	248.345
350	250	10	300	45.0	112022	244.346
350	250	16	300	47.5	112050	248.346
350	300	10	300	50.0	112023	244.366
350	300	16	300	52.5	112051	248.366
400*	200	10	300	45.6	150256	244.327
400*	200	16	300	50.5	150257	248.327
400	250	10	300	49.1	150258	244.347
400	250	16	300	54.6	150259	248.347
400	300	10	300	54.4	150276	244.367
400	300	16	300	59.4	150277	248.367
500*	300	10	600	111.0	150262	-
500*	300	16	600	111.0	150263	-
500*	400	10	600	109.6	150266	-
500*	400	16	600	130.6	150267	-
600*	400	10	600	210.0	150268	-
600*	400	16	600	242.0	150269	-
600	500	10	600	148.5	150270	-
600	500	16	600	189.5	150271	-
700	500	10	600	281.0	150272	-
700	500	16	600	311.0	150273	-
700	600	10	600	195.4	150274	-
700	600	16	600	236.4	150275	-

* to factory standards

Reduction flange, stud bolts on both sides (XR)

Fig. 2085

DN ₁	DN ₂	PN bar	b mm	weight kg	item no.	Suissetec
80	50	10,16	28	5.6		-
100	50	10,16	40	6.3		-
100	80	10	60	14.0	212350	271.279
100	80	16	60	14.0	212350	271.479
125	80	10	40	11.0	212346	271.281
125	80	16	40	11.0	212346	271.481
125	100	10	60	11.2	212332	271.321
125	100	16	60	11.2	212332	271.521
150	100	10	40	14.8	212334	271.322
150	100	16	40	14.8	212334	271.522
150	125	10	60	21.0	212335	271.342
150	125	16	60	21.0	212335	271.542
200	150	10	50	24.0	212340	271.363
200	150	16	50	24.0	212357	271.563
250*	200	10	46	32.0		271.384
250*	200	16	46	32.0		271.584

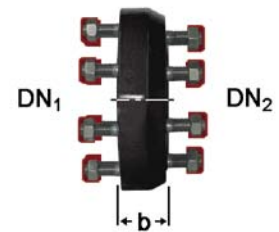

Flange with boreholes according to DIN EN 1092 part 2

* to EN 545 series A

Reduction flange, stud bolts on one side (XR)

Fig. 2085

DN ₁	DN ₂	PN bar	b mm	weight kg	item no.	Suissetec
125	50	10,16	40	7.5	212331	-
150	50	10,16	40	9.5		-
150	80	10	31	11.0	212347	271.282
150	80	16	31	11.0	212347	271.482
200	50	10	40	13.5		-
200	50	16	40	13.3		-
200*	80	10	40	15.0		271.283
200*	80	16	40	15.0		271.483
200*	100	10	40	14.0	212338	271.323
200*	100	16	40	14.0		271.523
200*	125	10	40	15.0		271.343
200*	125	16	40	15.0		271.543
250*	80	10	31	23.0		271.284
250*	80	16	31	23.0		271.484

To work specifications

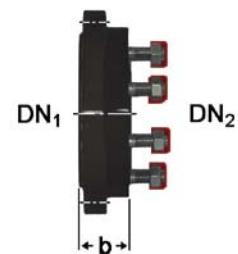

Flange with boreholes according to DIN EN 1092 part 2

* to EN 545 series A

ecofit® dummy flanges and connecting pieces with flange connectors

Adapter fittings made of ductile cast iron (EN-GJS) to EN 545 standard.

Thick epoxy-resin coating (min. 250 µm) to DIN 3476 standard.

PN > 16 on request.



Dummy flange, flax (X)

Fig. 2098

DN	PN bar	D mm	b mm	weight kg	item no.	Suissetec
40	10	150	19	2.5	150279	271.115
40	16	150	19	2.5	150279	-
50	10	165	19	3.0	150280	271.116
50	16	165	19	3.0	150280	-
65	10	185	19	4.0	150281	271.117
65	16	185	19	4.0	150281	-
80	10	200	19	3.6	150282	271.118
80	16	200	19	3.6	150282	-
100	10	220	19	4.3	150283	271.119
100	16	220	19	4.3	150283	-
125	10	250	19	5.6	150284	271.121
125	16	250	19	5.6	150284	-
150	10	285	19	7.2	150285	271.122
150	16	285	19	7.2	150285	-
200	10	340	20	11.0	150286	271.123
200	16	340	20	10.8	150287	271.143
250	10	400	22	16.9	150288	271.124
250	16	400	22	16.6	150289	271.144
300	10	455	24.5	26.0	150290	271.125
300	16	455	24.5	25.5	150291	271.145

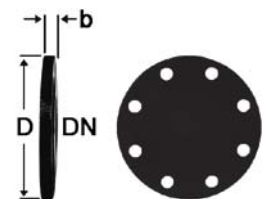

Flange with boreholes according to DIN EN 1092 part 2

Option: with thread

Dummy flange, domes (X)

Fig. 2099

DN	PN bar	D mm	b mm	weight kg	item no.	Suissetec
350	10	505	24.5	33.0	150292	271.126
350	16	520	26.5	37.0	150293	271.146
400	10	565	24.5	41.0	150294	271.127
400	16	580	28	49.0	150295	271.147
500	10	670	26.5	65.0	150296	-
500	16	715	31.5	85.5	150297	-
600	10	780	30	99.5	150298	-
600	16	840	36	136.0	150299	-
700	10	875	32.5	147.0	150300	-
700	16	910	39.5	179.0	150301	-

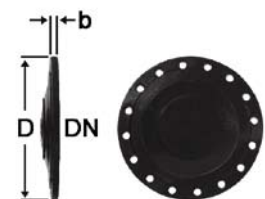

Flange with boreholes according to DIN EN 1092 part 2

Option: with thread

Subject to alteration without notice

Connecting pieces and gaskets

Flange connection PN 10 / galvanised

Fig. 2007.10

DN	D mm	d mm	b mm	screws	nuts	weight kg	item no.	Suissetec
80	142	89	4	M16x70/38	8x M16	0.8	204973	877.118
100	162	115	5	M16x70/38	8x M16	0.8	204974	877.119
125	192	141	5	M16x70/38	8x M16	0.8	204975	877.121
150	218	169	5	M20x80/46	8x M20	1.4	204976	877.122
200	273	220	6	M20x80/46	8x M20	1.5	204977	877.123
250	328	273	6	M20x80/46	12x M20	1.6	204978	877.124
300	378	324	6	M20x80/46	12x M20	1.6	204979	877.125
350	438	368	7	M20x80/46	16x M20	1.8	204980	877.126
400	489	407	7	M24x100/54	16x M24	2.1	204981	877.127
500	594	508	7	M24x100/54	20x M24	2.4	204982	877.128
600	695	610	7	M27x110/60	20x M27	3.9	204983	-

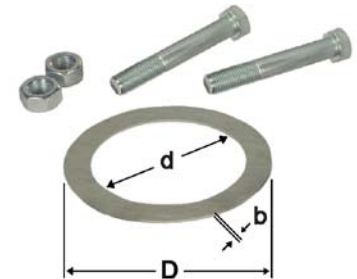

Supply includes:
 Hexagonal-head bolts (DIN 931) with nuts (DIN934) in St. 8.8, galvanised
 1 Profile joint type G-ST with steel reinforcement / materiel NBR-DUO
 (DIN EN 1514-1), water and gas quality

The tightness of fittings with flanges is only ensured by using of profile joint with steel reinforcement type G-ST.

Flange connection > PN 16 on request

Flange connection PN 16 / galvanised

Fig. 2007.16

DN	D mm	d mm	b mm	screws	nuts	weight kg	item no.	Suissetec
80	142	89	4	M16x70/38	8x M16	0.8	204973	877.138
100	162	115	5	M16x70/38	8x M16	0.8	204974	877.139
125	192	141	5	M16x70/38	8x M16	0.8	204975	877.141
150	218	169	5	M20x80/46	8x M20	1.4	204976	877.142
200	273	220	6	M20x80/46	12x M20	1.6	205005	877.143
250	329	273	6	M24x90/54	12x M24	1.9	205006	877.144
300	384	324	6	M24x100/54	12x M24	1.9	205007	877.145
350	445	368	7	M24x100/54	16x M24	2.2	205008	877.146
400	497	420	7	M27x110/60	16x M27	3.7	205009	877.147
500	618	520	7	M30x110/66	20x M30	5.2	205010	877.148
600	735	620	7	M33x130/72	20x M33	7.2	205011	-

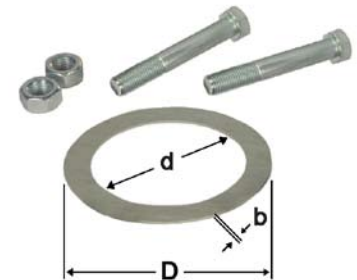

Supply includes:
 Hexagonal-head bolts (DIN 931) with nuts (DIN934) in St. 8.8, galvanised
 1 Profile joint type G-ST with steel reinforcement / materiel NBR-DUO
 (DIN EN 1514-1), water and gas quality

The tightness of fittings with flanges is only ensured by using of profile joint with steel reinforcement type G-ST.

Flange connection > PN 16 on request

Subject to alteration without notice

Connecting pieces and gaskets

Flange connection PN 10 / V2A

Fig. 2008.10

DN	D mm	d mm	b mm	screws	nuts	weight kg	item no.	Suissetec
80	142	89	4	M16x70/38	8x M16	0.8	877.318	
100	162	115	5	M16x70/38	8x M16	0.8	877.319	
125	192	141	5	M16x70/38	8x M16	0.8	877.321	
150	218	169	5	M20x80/46	8x M20	1.4	877.322	
200	273	220	6	M20x80/46	8x M20	1.5	877.323	
250	328	273	6	M20x80/46	12x M20	1.6	877.324	
300	378	324	6	M20x80/46	12x M20	1.6	877.325	
350	438	368	7	M20x80/46	16x M20	1.8	877.326	
400	489	407	7	M24x100/54	16x M24	2.1	877.327	
500	594	508	7	M24x100/54	20x M24	2.4	877.328	
600	695	610	7	M27x110/60	20x M27	3.9	-	

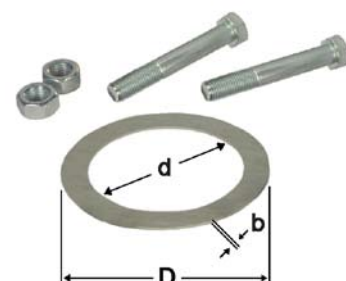

Supply includes:
 Hexagonal-head bolts (DIN 931) with nuts (DIN934) in V2A,
 1 Profile joint type G-ST with steel reinforcement / materiel NBR-DUO
 (DIN EN 1514-1), water and gas quality

The tightness of fittings with flanges is only ensured by using of profile joint with steel reinforcement type G-ST.

Flange connection > PN 16 on request

Flange connection PN 16 / V2A

Fig. 2008.16

DN	D mm	d mm	b mm	screws	nuts	weight kg	item no.	Suissetec
80	142	89	4	M16x70/38	8x M16	0.8	877.338	
100	162	115	5	M16x70/38	8x M16	0.8	877.339	
125	192	141	5	M16x70/38	8x M16	0.8	877.341	
150	218	169	5	M20x80/46	8x M20	1.4	877.342	
200	273	220	6	M20x80/46	12x M20	1.6	877.343	
250	329	273	6	M24x90/54	12x M24	1.9	877.344	
300	384	324	6	M24x100/54	12x M24	1.9	877.345	
350	445	368	7	M24x100/54	16x M24	2.2	877.346	
400	497	420	7	M27x110/60	16x M27	3.7	877.347	
500	618	520	7	M30x110/66	20x M30	5.2	877.348	
600	735	620	7	M33x130/72	20x M33	7.2	-	

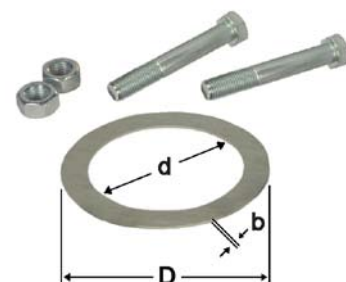

Supply includes:
 Hexagonal-head bolts (DIN 931) with nuts (DIN934) in V2A,
 1 Profile joint type G-ST with steel reinforcement / materiel NBR-DUO
 (DIN EN 1514-1), water and gas quality

The tightness of fittings with flanges is only ensured by using of profile joint with steel reinforcement type G-ST.

Flange connection > PN 16 on request

Subject to alteration without notice

Connecting pieces and gaskets

Dichtung Typ G-St PN 10 in water and gas quality

DN	D mm	d mm	b mm	weight kg	item no.	Suissetec
80	142	89	4	0.8	495891	271.818
100	162	115	5	0.8	495892	271.819
125	192	141	5	0.8	495893	271.821
150	218	169	5	1.4	495894	271.822
200	273	220	6	1.5	495895	271.823
250	328	273	6	1.6	495896	271.824
300	378	324	6	1.6	495897	271.825
350	438	368	7	1.8	495942	271.826
400	489	407	7	2.1	495943	271.827
500	594	508	7	2.4	495944	-
600	695	610	7	3.9	495945	-

zu Fig. 2007/2008.10

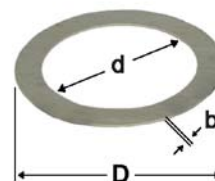

1 Profile joint type G-ST with steel reinforcement / materiel NBR-DUO (DIN EN 1514-1), water and gas quality

The tightness of fittings with flanges is only ensured by using of profile joint with steel reinforcement type G-ST.

Dichtung Typ G-St PN 16 in water and gas quality

DN	D mm	d mm	b mm	weight kg	item no.	Suissetec
80	142	89	4	0.8	495891	-
100	162	115	5	0.8	495892	-
125	192	141	5	0.8	495893	-
150	218	169	5	1.4	495894	-
200	273	220	6	1.6	495895	-
250	329	273	6	1.9	495896	-
300	384	324	6	1.9	495398	-
350	445	368	7	2.2	495946	-
400	497	420	7	3.7	495947	-
500	618	520	7	5.2	495948	-
600	735	620	7	7.2	495949	-

zu Fig. 2007/2008.16

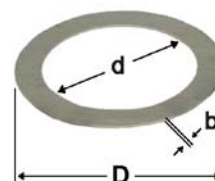

1 Profile joint type G-ST with steel reinforcement / materiel NBR-DUO (DIN EN 1514-1), water and gas quality

The tightness of fittings with flanges is only ensured by using of profile joint with steel reinforcement type G-ST.

Installation instructions for piping with flange connections

1. General remarks

Following the instructions below will guarantee professional and correct installation work.

2. Making the connection

To complete the flange connection between the two pipes with their flanges (A and B), the sealing set with gasket, bolts and nuts (C) is needed.

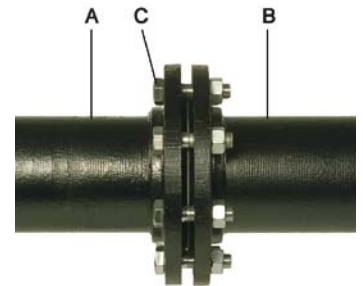

3. Cleaning the flanges

The surfaces of the seal, gasket and the threaded holes must be cleaned. Any paint residue must be removed.

4. Assembly of the connection

Recommendations for the installation.

Pipes and adapter fittings with flanges must be carefully bedded-in. Back-filling to the sides of the piping and over the top of the pipes is to be carried out with care.

Varying loads cannot be taken up by the fixed pipe connections. On no account should the pipes and adapter pieces be laid on rocks or other materials, they should be laid in ground that is free of stones. Rocky ground should be covered with at least a 15 cm thick layer of sand, gravel or loose chippings.

5. Alignment of the flange holes

For flange connections in general, the holes should be positioned so that no hole lies in the vertical plane at right-angles to the plane of the pipeline.

The sequence for tightening up the bolts (in the order shown by the numbered sketches)

The nuts should be tightened using a torque wrench. (the torque is dependent on the size of the bolts and their class (5.6, 5.8))

We will be pleased to supply you with information on the required torque.

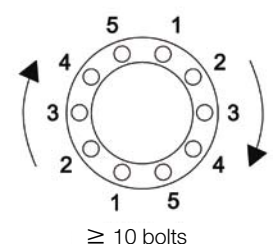
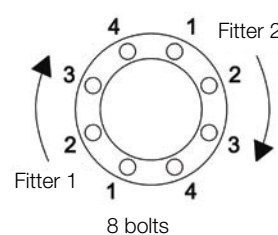
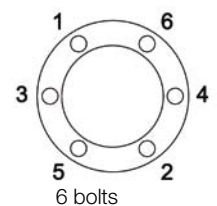
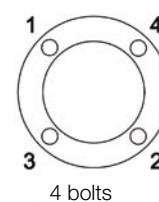

6. Remarks concerning the installation of flanged adapter fittings (especially Fig. 2084)

Because of the differing numbers of bolt-holes on the two sides of flanged tapers, there is a danger that pipes and adapter fittings fitted after the taper could be falsely oriented. The possible distortion (dependent on diameter) can be up to 22.5°

Attention!

For larger diameters, the distortion may hardly be noticeable.

